

 **KAISER**<sup>TM</sup>  
PERFORMANCE BATTERIES



| CATÁLOGO DE PRODUCTO |

[www.kaiser.com.ec](http://www.kaiser.com.ec)

síguenos en



BateriasKaiser



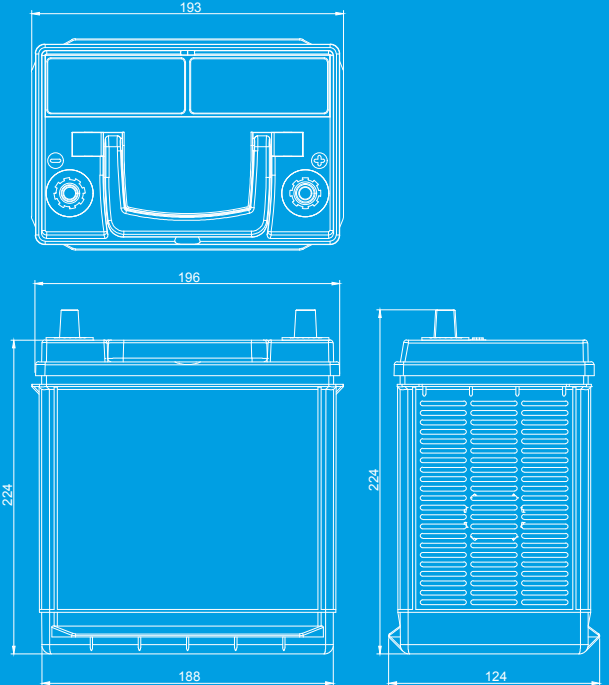

### HYBRID® C4 LIBRE Y BAJO MANTENIMIENTO SEGUN SU APLICACION

CAPACIDADES		DIMENSIONES		DETALLES	
VOLTAJE	12V	LARGO	193 mm	CAJA	PP DE ALTA CALIDAD
CAP NOMINAL	47	ANCHO	124 mm	CUBIERTA	TAPONES POD
RES.(min)	61	ALTO	224 mm	SEPARADORES	POLIETILENO
CCA (-18°C)	425				
CCA (0°C)	520				
CCA (27°C)	610				

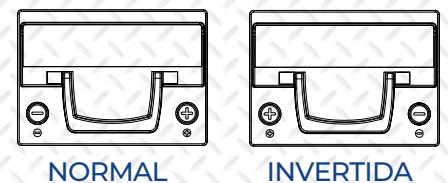
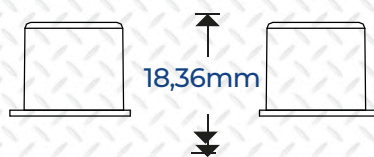
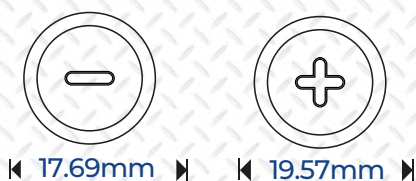

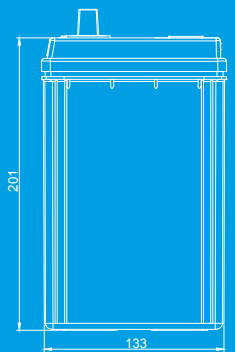
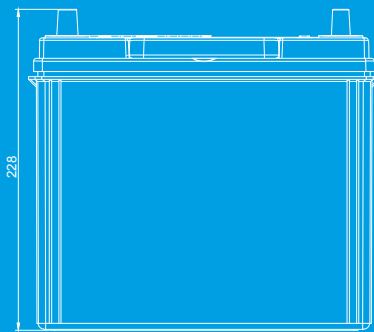
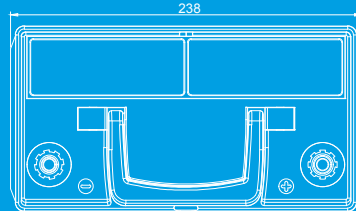

## HYBRID® C4 LIBRE Y BAJO MANTENIMIENTO SEGUN SU APLICACION

CAPACIDADES		DIMENSIONES		DETALLES	
VOLTAJE	12V	LARGO	238 mm	CAJA	PP DE ALTA CALIDAD
CAP NOMINAL	57	ANCHO	133 mm	CUBIERTA	TAPONES POD
RES.(min)	79	ALTO	228 mm	SEPARADORES	POLIETILENO
CCA (-18°C)	460				
CCA (0°C)	570				
CCA (27°C)	675				



17.69mm



19.57mm



18,36mm

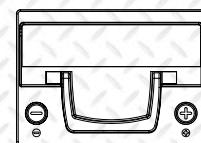

NORMAL

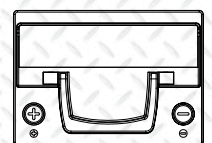

INVERTIDA



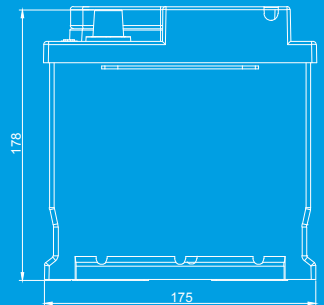
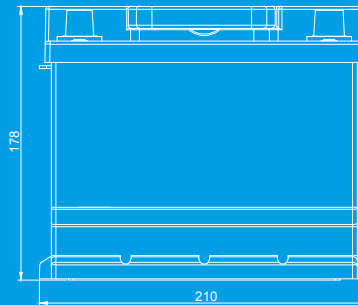
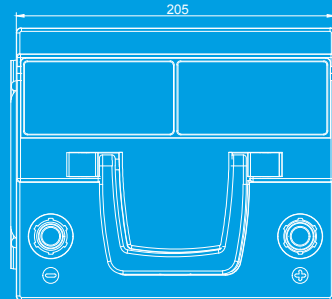

**HYBRID<sup>®</sup>**  
**C4** LIBRE Y BAJO MANTENIMIENTO  
SEGUN SU APLICACION

CAPACIDADES		DIMENSIONES		DETALLES	
VOLTAJE	12V	LARGO	205 mm	CAJA	PP DE ALTA CALIDAD
CAP NOMINAL	50	ANCHO	175 mm	CUBIERTA	TAPONES POD
RES.(min)	63	ALTO	178 mm	SEPARADORES	POLIETILENO
CCA (-18°C)	440				
CCA (0°C)	530				
CCA (27°C)	620				



◀ 17.69mm ▶



◀ 19.57mm ▶



18,36mm

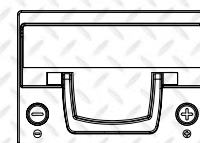

NORMAL



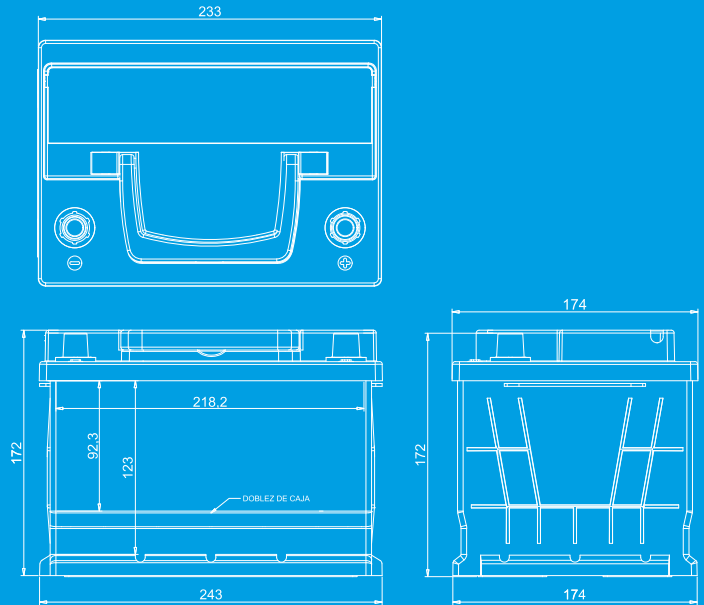

## HYBRID® C4

LIBRE Y BAJO MANTENIMIENTO  
SEGUN SU APLICACION

CAPACIDADES		DIMENSIONES		DETALLES	
VOLTAJE	HP 12V MP 12V	LARGO	233 mm	CAJA	PP DE ALTA CALIDAD
CAP NOMINAL	60 65	ANCHO	174 mm	CUBIERTA	TAPONES POD
RES.(min)	79 90	ALTO	172 mm	SEPARADORES	POLIETILENO
CCA (-18°C)	470 560				
CCA (0°C)	570 680				
CCA (27°C)	670 805				

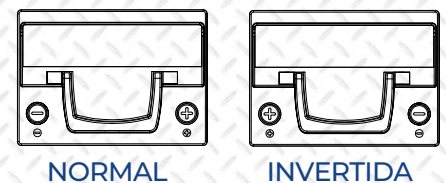
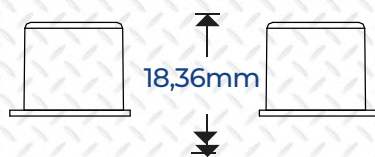
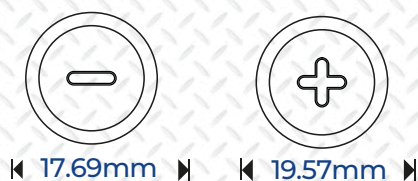

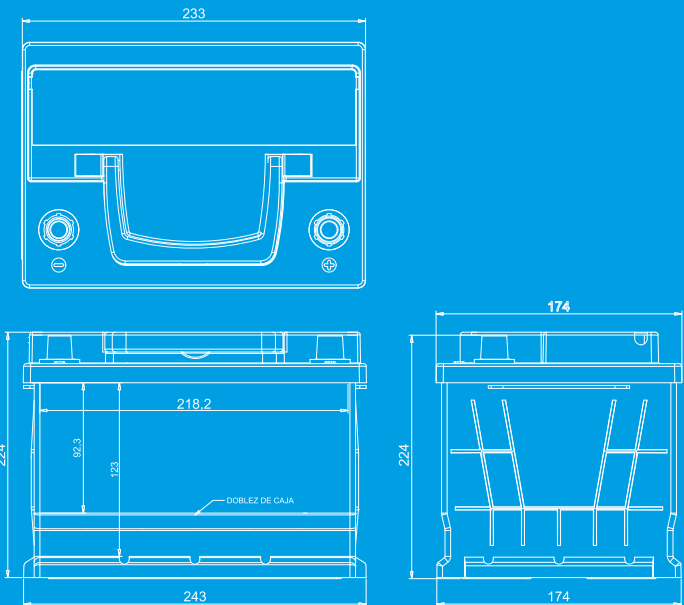

## HYBRID® C4

LIBRE Y BAJO MANTENIMIENTO  
SEGUN SU APLICACION

CAPACIDADES		DIMENSIONES		DETALLES	
VOLTAJE	HP 12V MP 12V	LARGO	233 mm	CAJA	PP DE ALTA CALIDAD
CAP NOMINAL	60 68	ANCHO	174 mm	CUBIERTA	TAPONES POD
RES.(min)	79 94	ALTO	224 mm	SEPARADORES	POLIETILENO
CCA (-18°C)	470 560				
CCA (0°C)	570 680				
CCA (27°C)	670 805				

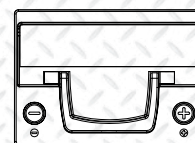
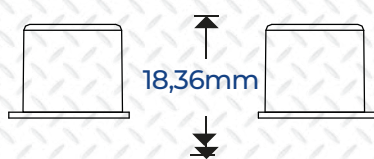
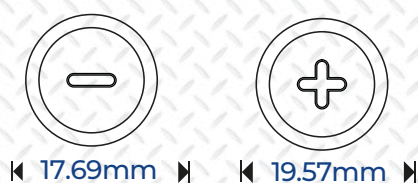

NORMAL



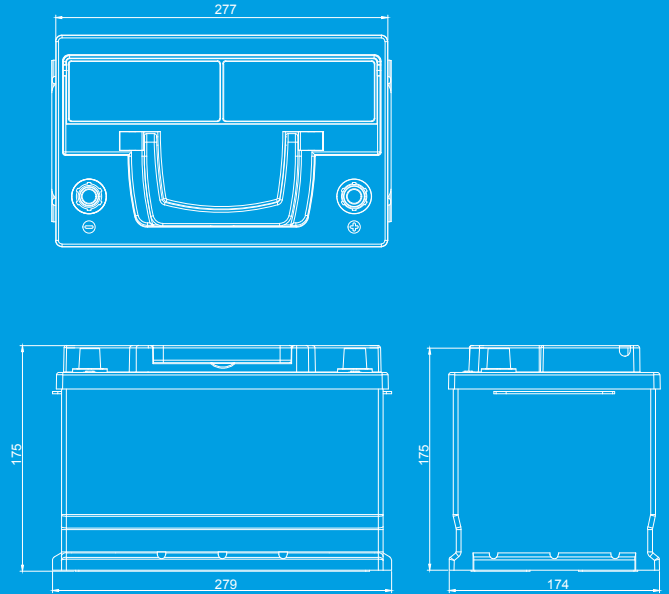

**HYBRID<sup>®</sup>**  
**C4** LIBRE Y BAJO MANTENIMIENTO  
SEGUN SU APLICACION

CAPACIDADES		DIMENSIONES		DETALLES	
VOLTAJE	12V	LARGO	277 mm	CAJA	PP DE ALTA CALIDAD
CAP NOMINAL	70	ANCHO	174 mm	CUBIERTA	TAPONES POD
RES.(min)	98	ALTO	175 mm	SEPARADORES	POLIETILENO
CCA (-18°C)	660				
CCA (0°C)	800				
CCA (27°C)	940				

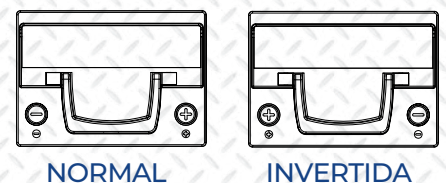
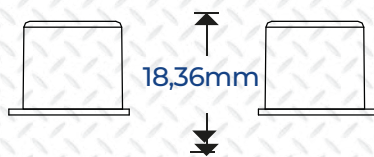
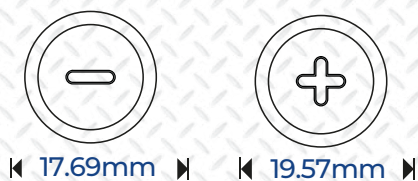

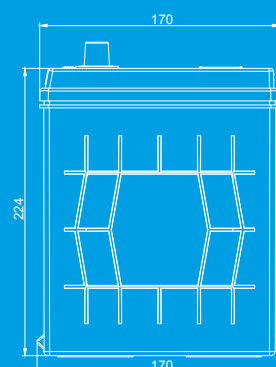
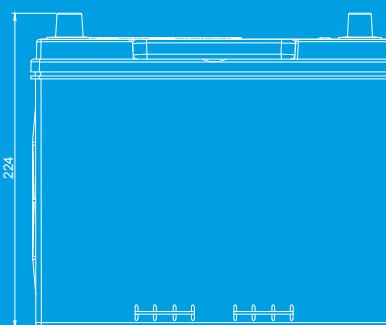
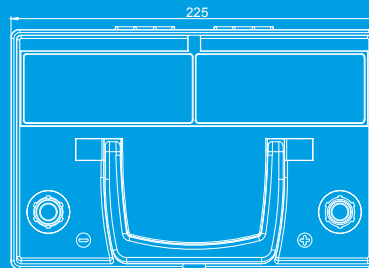

## HYBRID® C4

LIBRE Y BAJO MANTENIMIENTO  
SEGUN SU APLICACION

CAPACIDADES		DIMENSIONES		DETALLES	
VOLTAJE	12V	LARGO	225 mm	CAJA	PP DE ALTA CALIDAD
CAP NOMINAL	70	ANCHO	170 mm	CUBIERTA	TAPONES POD
RES.(min)	116	ALTO	224 mm	SEPARADORES	POLIETILENO
CCA (-18°C)	595				
CCA (0°C)	730				
CCA (27°C)	860				

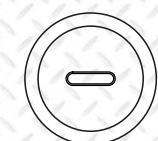

◀ 17.69mm ▶



◀ 19.57mm ▶



↑ 18,36mm ↓

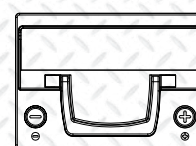

NORMAL



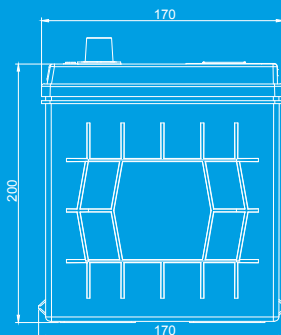
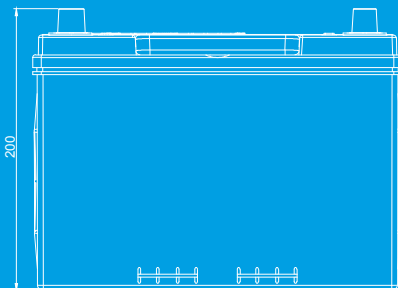
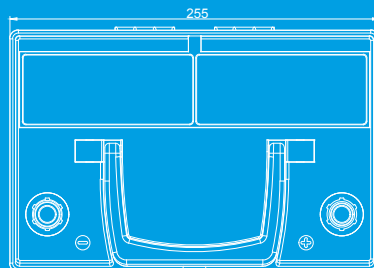

## HYBRID® C4

LIBRE Y BAJO MANTENIMIENTO  
SEGUN SU APLICACION

CAPACIDADES			DIMENSIONES		DETALLES	
VOLTAJE	HP	MP	LARGO	255 mm	CAJA	PP DE ALTA CALIDAD
CAP NOMINAL	70	80	ANCHO	170 mm	CUBIERTA	TAPONES POD
RES.(min)	89	108	ALTO	200 mm	SEPARADORES	POLIETILENO
CCA (-18°C)	550	740				
CCA (0°C)	710	900				
CCA (27°C)	835	1060				

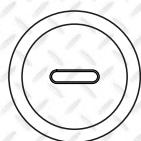

17.69mm



19.57mm



18,36mm

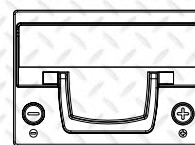

NORMAL

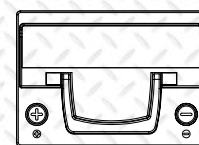

INVERTIDA

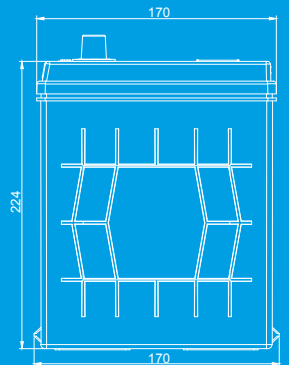
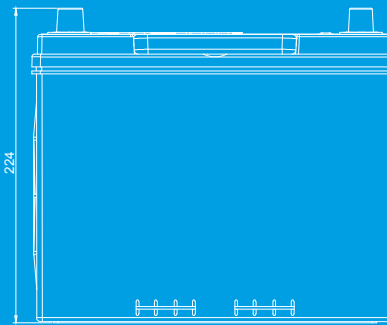
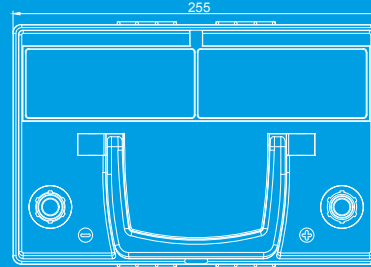

### HYBRID® C4 LIBRE Y BAJO MANTENIMIENTO SEGUN SU APLICACION

CAPACIDADES			DIMENSIONES		DETALLES	
VOLTAJE	HP	MP	LARGO	255 mm	CAJA	PP DE ALTA CALIDAD
CAP NOMINAL	70	85	ANCHO	170 mm	CUBIERTA	TAPONES POD
RES.(min)	92	119	ALTO	224 mm	SEPARADORES	POLIETILENO
CCA (-18°C)	550	660				
CCA (0°C)	730	865				
CCA (27°C)	860	1030				

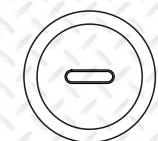

17.69mm



19.57mm



18,36mm

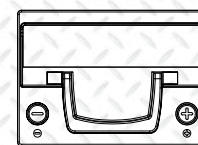

NORMAL

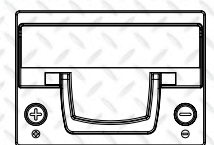

INVERTIDA



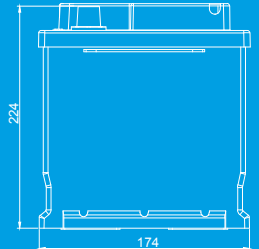
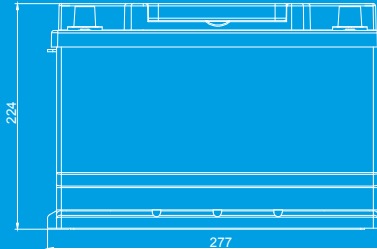
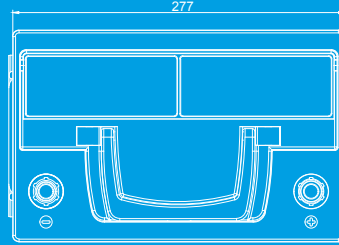

**HYBRID<sup>®</sup>**  
**C4** LIBRE Y BAJO MANTENIMIENTO  
SEGUN SU APLICACION

CAPACIDADES		DIMENSIONES		DETALLES	
VOLTAJE	12V	LARGO	277 mm	CAJA	PP DE ALTA CALIDAD
CAP NOMINAL	77	ANCHO	174 mm	CUBIERTA	TAPONES POD
RES.(min)	128	ALTO	224 mm	SEPARADORES	POLIETILENO
CCA (-18°C)	670				
CCA (0°C)	810				
CCA (27°C)	950				



◀ 17.69mm ▶



◀ 19.57mm ▶



18,36mm

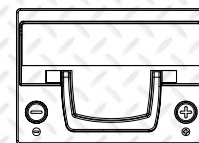
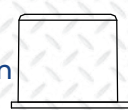

NORMAL

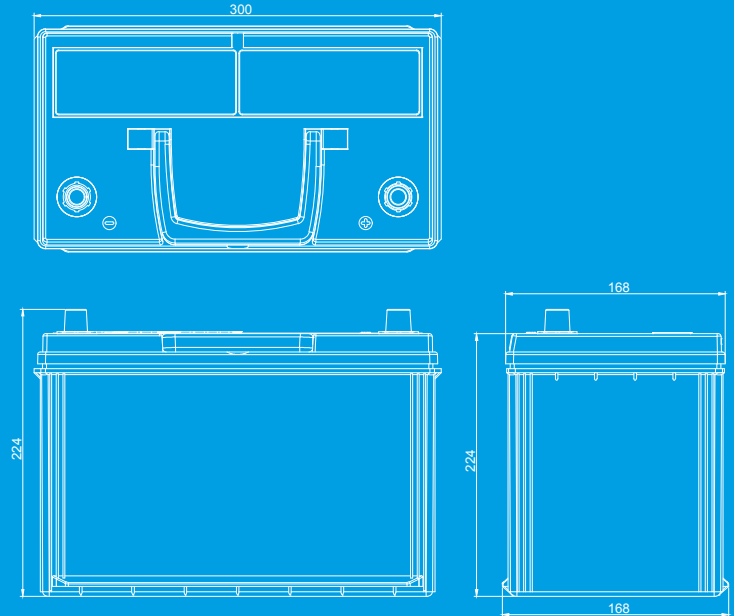

### HYBRID® C4 LIBRE Y BAJO MANTENIMIENTO SEGUN SU APLICACION

CAPACIDADES			DIMENSIONES		DETALLES	
	HP	MP				
VOLTAJE	12V	12V	LARGO	300 mm	CAJA	PP DE ALTA CALIDAD
CAP NOMINAL	90	103	ANCHO	168 mm	CUBIERTA	TAPONES POD
RES.(min)	153	188	ALTO	224 mm	SEPARADORES	POLIETILENO
CCA (-18°C)	755	930				
CCA (0°C)	935	1150				
CCA (27°C)	1115	1370				

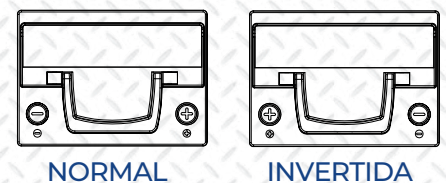
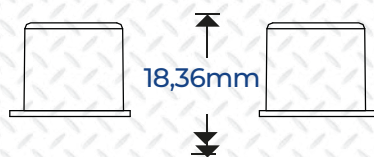
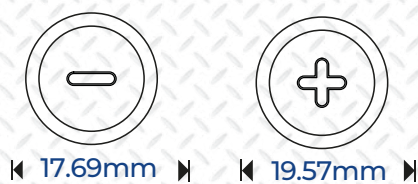



# C5

100%  
SEALED  
BATTERY







**C5** 100% SEALED BATTERY

CAPACIDADES		DIMENSIONES		DETALLES	
VOLTAJE	12V	LARGO	342 mm	CAJA	PP DE ALTA CALIDAD
CAP NOMINAL	100	ANCHO	166 mm	CUBIERTA	TAPONES POD
RES.(min)	159	ALTO	200 mm	SEPARADORES	POLIETILENO
CCA (-18°C)	875				
CCA (0°C)	1036				
CCA (27°C)	1192				

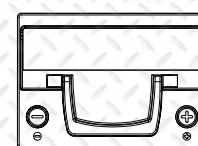
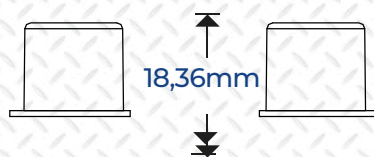
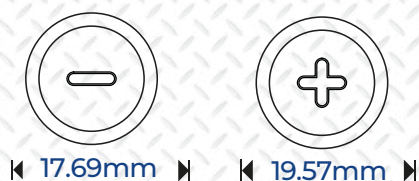

NORMAL





**C5** 100% SEALED BATTERY

CAPACIDADES		DIMENSIONES		DETALLES	
VOLTAJE	12V	LARGO	286 mm	CAJA	PP DE ALTA CALIDAD
CAP NOMINAL	90	ANCHO	185 mm	CUBIERTA	TAPONES POD
RES.(min)	148	ALTO	192 mm	SEPARADORES	POLIETILENO
CCA (-18°C)	820				
CCA (0°C)	967				
CCA (27°C)	1112				

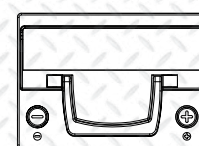
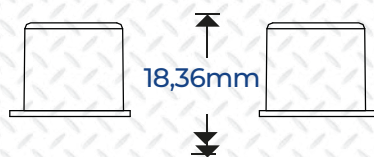
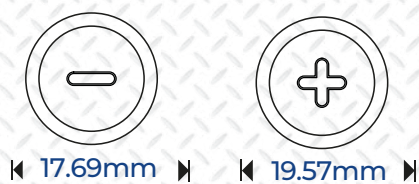

NORMAL





**C5** 100% SEALED BATTERY

CAPACIDADES		DIMENSIONES		DETALLES	
VOLTAJE	12V	LARGO	286 mm	CAJA	PP DE ALTA CALIDAD
CAP NOMINAL	90	ANCHO	185 mm	CUBIERTA	TAPONES POD
RES.(min)	138	ALTO	192 mm	SEPARADORES	POLIETILENO
CCA (-18°C)	720				
CCA (0°C)	850				
CCA (27°C)	980				

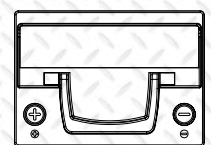
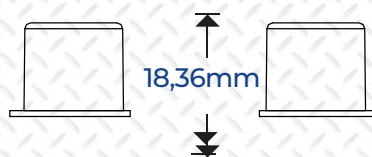
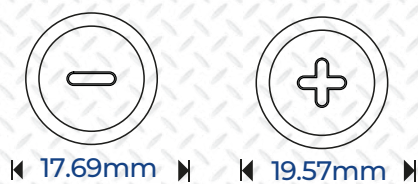

INVERTIDA





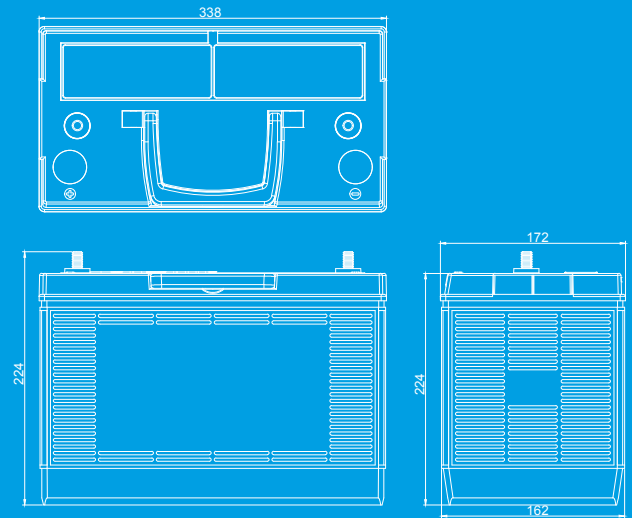

## ESPECIFICACIONES Y CARACTERÍSTICAS

CAPACIDADES		DIMENSIONES		DETALLES	
VOLTAJE	12V	LARGO	338 mm	CAJA	PP DE ALTA CALIDAD
CAP NOMINAL	105	ANCHO	162 mm	CUBIERTA	TAPONES POD
RES.(min)	182	ALTO	224 mm	SEPARADORES	POLIETILENO
CCA (-18°C)	745				
CCA (0°C)	908				
CCA (27°C)	1070				

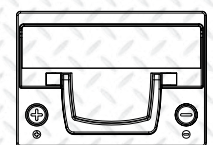
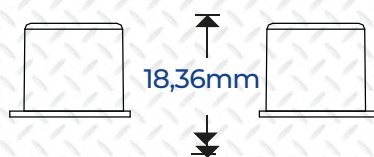
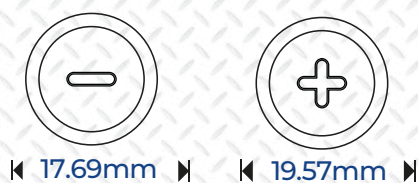

INVERTIDA



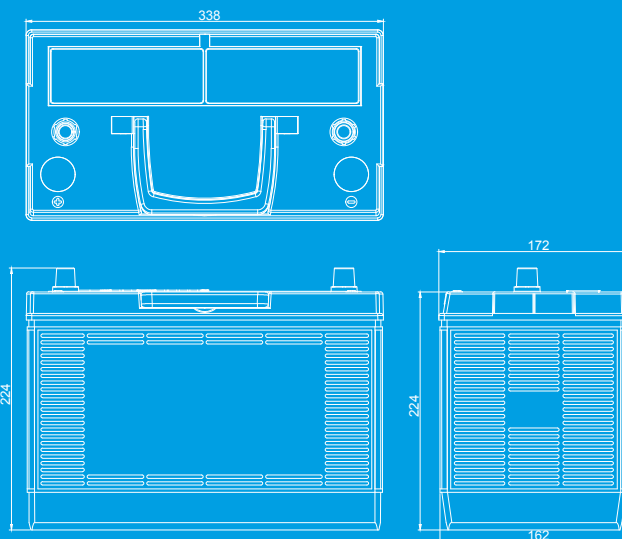

## ESPECIFICACIONES Y CARACTERÍSTICAS

CAPACIDADES		DIMENSIONES		DETALLES	
VOLTAJE	12V	LARGO	338 mm	CAJA	PP DE ALTA CALIDAD
CAP NOMINAL	105	ANCHO	162 mm	CUBIERTA	TAPONES POD
RES.(min)	182	ALTO	224 mm	SEPARADORES	POLIETILENO
CCA (-18°C)	745				
CCA (0°C)	908				
CCA (27°C)	1070				

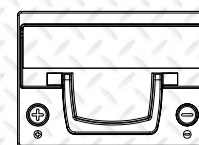
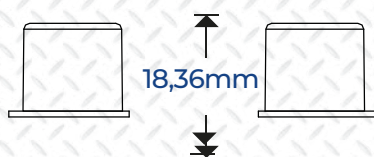
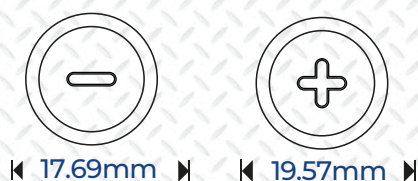

INVERTIDA

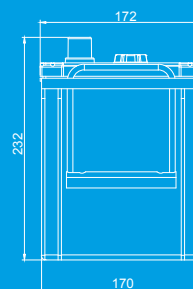
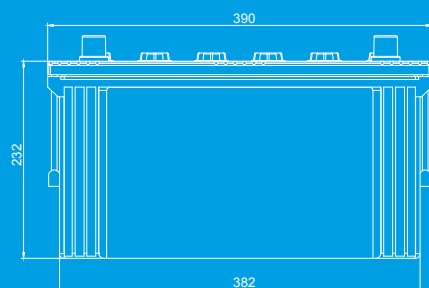
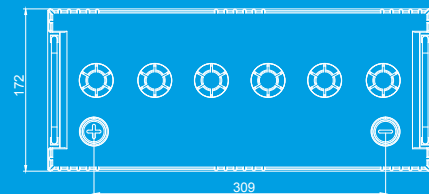

## ESPECIFICACIONES Y CARACTERÍSTICAS

CAPACIDADES		DIMENSIONES		DETALLES	
VOLTAJE	12V	LARGO	390 mm	CAJA	PP DE ALTA CALIDAD
CAP NOMINAL	130	ANCHO	170 mm	CUBIERTA	TAPONES POD
RES.(min)	228	ALTO	232 mm	SEPARADORES	POLIETILENO
CCA (-18°C)	840				
CCA (0°C)	975				
CCA (27°C)	1110				



◀ 17.69mm ▶



◀ 19.57mm ▶

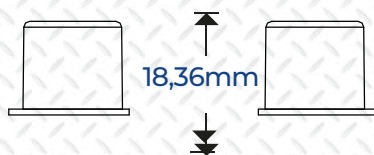

18,36mm

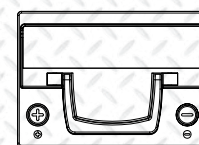

INVERTIDA



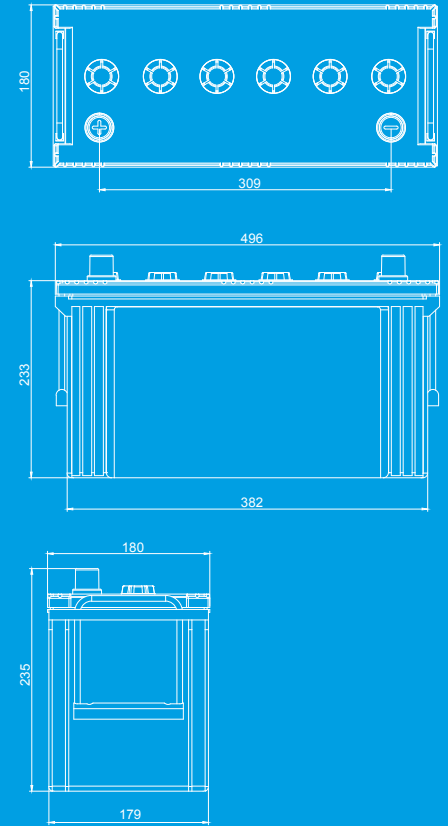

## ESPECIFICACIONES Y CARACTERÍSTICAS

CAPACIDADES		DIMENSIONES		DETALLES	
VOLTAJE	12V	LARGO	496 mm	CAJA	PP DE ALTA CALIDAD
CAP NOMINAL	140	ANCHO	180 mm	CUBIERTA	TAPONES POD
RES.(min)	270	ALTO	235 mm	SEPARADORES	POLIETILENO
CCA (-18°C)	880				
CCA (0°C)	1080				
CCA (27°C)	1310				

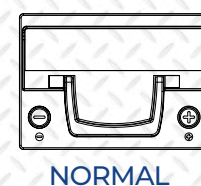
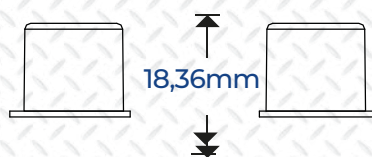
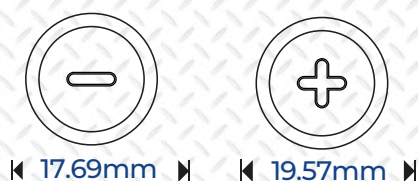

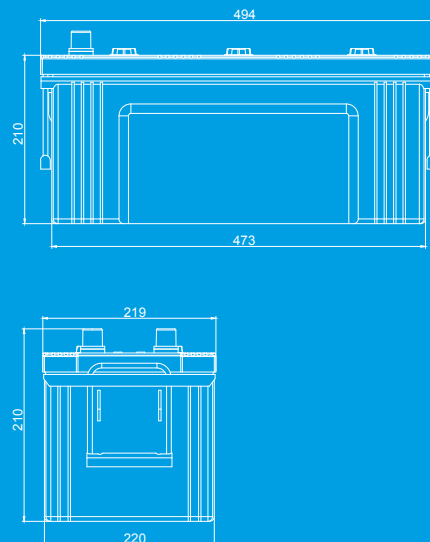

### ESPECIFICACIONES Y CARACTERÍSTICAS

CAPACIDADES		DIMENSIONES		DETALLES	
VOLTAJE	12V	LARGO	494 mm	CAJA	PP DE ALTA CALIDAD
CAP NOMINAL	135	ANCHO	220 mm	CUBIERTA	TAPONES POD
RES.(min)	270	ALTO	210mm	SEPARADORES	POLIETILENO
CCA (-18°C)	920				
CCA (0°C)	1140				
CCA (27°C)	1355				



◀ 17.69mm ▶



◀ 19.57mm ▶

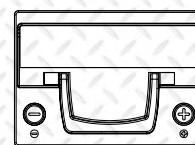
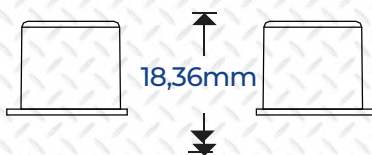

NORMAL



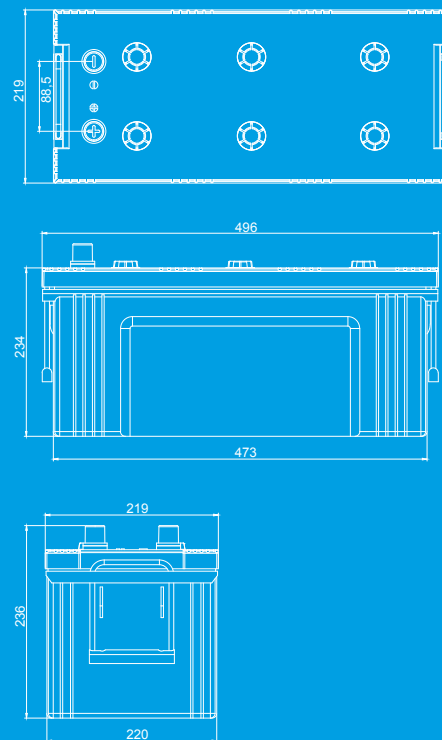

## ESPECIFICACIONES Y CARACTERÍSTICAS

CAPACIDADES		DIMENSIONES		DETALLES	
VOLTAJE	12V	LARGO	496 mm	CAJA	PP DE ALTA CALIDAD
CAP NOMINAL	150	ANCHO	220 mm	CUBIERTA	TAPONES POD
RES.(min)	293	ALTO	236 mm	SEPARADORES	POLIETILENO
CCA (-18°C)	920				
CCA (0°C)	1140				
CCA (27°C)	1355				

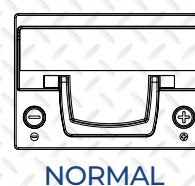
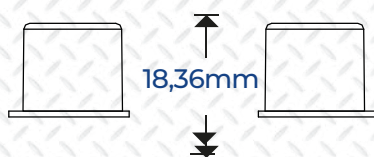
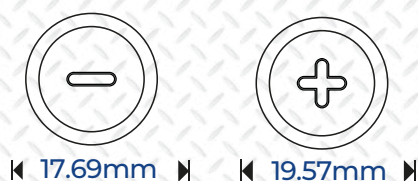

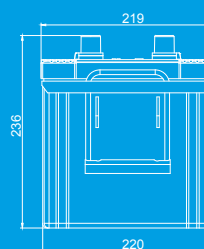
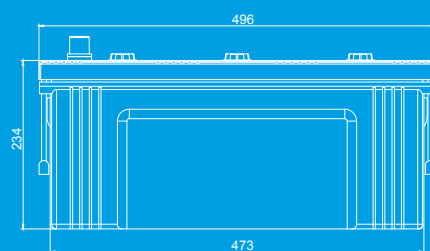
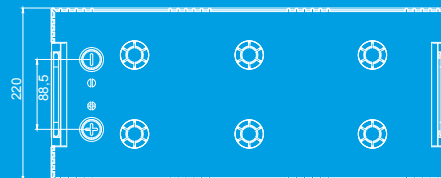

## ESPECIFICACIONES Y CARACTERÍSTICAS

CAPACIDADES		DIMENSIONES		DETALLES	
VOLTAJE	12V	LARGO	496 mm	CAJA	PP DE ALTA CALIDAD
CAP NOMINAL	165	ANCHO	220 mm	CUBIERTA	TAPONES POD
RES.(min)	330	ALTO	236 mm	SEPARADORES	POLIETILENO
CCA (-18°C)	1120				
CCA (0°C)	1265				
CCA (27°C)	1480				



17.69mm



19.57mm

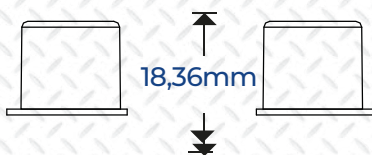

18,36mm

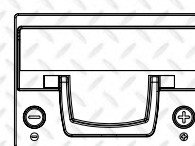

NORMAL



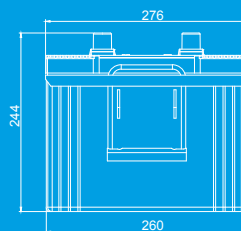
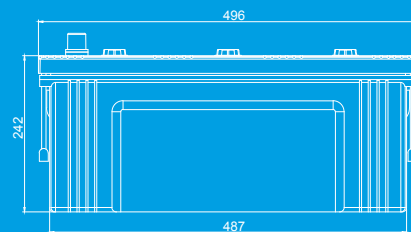
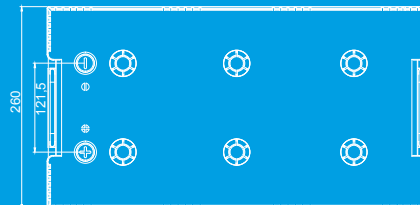

## ESPECIFICACIONES Y CARACTERÍSTICAS

CAPACIDADES		DIMENSIONES		DETALLES	
VOLTAJE	12V	LARGO	496 mm	CAJA	PP DE ALTA CALIDAD
CAP NOMINAL	235	ANCHO	260 mm	CUBIERTA	TAPONES POD
RES.(min)	496	ALTO	244 mm	SEPARADORES	POLIETILENO
CCA (-18°C)	1340				
CCA (0°C)	1660				
CCA (27°C)	1975				



17.69mm



19.57mm

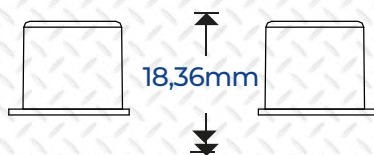

18,36mm

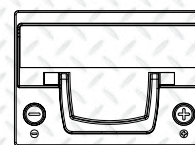

NORMAL



**KAISER**<sup>TM</sup>  
P E R F O R M A N C E   B A T T E R I E S